

MICROMASTER 420

Getting Started Guide



This Getting Started Guide allows easy and efficient commissioning of the MICROMASTER 420 inverter. For further technical information, please refer to the **Operating Instructions** and the **Reference Manual** on the CD-ROM supplied with the MICROMASTER 420 inverter.

Contents

1	Mechanical Installation	3
2	Electrical Installation	4
3	Avoiding Electro-Magnetic Interference	5
4	Commissioning the MICROMASTER 420 Inverter	6
4.1	Default Settings	6
4.2	Commissioning with Getting Started Guide	7
4.3	Commissioning with the Status Display Panel	7
4.4	Commissioning with the Basic Operator Panel	8
4.5	Changing parameters and settings using a 'BOP' / 'AOP'	9
5	Quick Commissioning	10
5.1	RESET Using P0010 & P0970	10
5.2	Motor Data for "Quick Commissioning"	11
5.3	Starting/Stopping the motor using a 'BOP' (P0700 = 1)	11
5.4	Commissioning with the Advanced Operator Panel (AOP)	11
5.5	Additional Control Applications	11
5.6	Further information ...	11
6	Changing the Display / Operator Panel	12
6.1	Changing single digits in Parameter values	12
7	Troubleshooting	13
7.1	With the Status Display Panel	13
7.2	With Operator Panels (BOP & AOP)	13
8	Parameterization of the Inverter Overview	14
8.1	Parameter Structure	15

Warnings, Cautions and Notes

The following Warnings, Cautions and Notes are provided for your safety and as a means of preventing damage to the product or components in the machines connected.

Specific Warnings, Cautions and Notes that apply to particular activities are listed at the beginning of the relevant sections.

Please read the information carefully, since it is provided for your personal safety and will also help prolong the service life of your MICROMASTER 420 inverter and the equipment you connect to it.



Warnings

- This equipment contains dangerous voltages and controls potentially dangerous rotating mechanical parts. Non-compliance with **Warnings** or failure to follow the instructions contained in this manual can result in loss of life, severe personal injury or serious damage to property.
 - Only suitably qualified personnel should work on this equipment, and only after becoming familiar with all safety notices, installation, operation and maintenance procedures contained in this manual. The successful and safe operation of this equipment is dependent upon its proper handling, installation, operation and maintenance.
 - The DC link of all MICROMASTER modules remains at a hazardous voltage level for 5 minutes after all voltages have been disconnected. Therefore always wait for 5 minutes after disconnecting the inverter from the power supply before carrying out work on any MICROMASTER modules.
 - This equipment is capable of providing internal motor overload protection in accordance with UL508C section 42. Refer to P0610 (level 3) and P0335. Motor overload protection can also be provided using an external PTC via a digital input.
 - This equipment is suitable for use in a circuit capable of delivering not more than 10,000 symmetrical amperes (rms), for a maximum voltage of 230/460V when protected by a time delay fuse (see Table on Page 93 of the Operating Instructions).
 - Class 1 60/75° copper wire only.
 - Refer to the Operating Instructions for tightening torques.
-



Caution

- Children and the general public must be prevented from accessing or approaching the equipment!
 - This equipment may only be used for the purpose specified by the manufacturer. Unauthorized modifications and the use of spare parts and accessories that are not sold or recommended by the manufacturer of the equipment can cause fires, electric shocks and injuries.
-

Notes

- Keep this Getting Started Guide within easy reach of the equipment and make them available to all users.
 - Whenever measuring or testing has to be performed on live equipment, the regulations of Safety Code VBG 4.0 must be observed, in particular § 8 'Permissible Deviations when Working on Live Parts'. Suitable electronic tools should be used.
 - Before carrying out any installation and commissioning procedures, you **must** read all safety instructions and warnings, including all warning labels attached to the equipment. Make sure that the warning labels are kept in a legible condition and ensure missing or damaged labels are replaced.
-

1 Mechanical Installation



Warning

THIS EQUIPMENT MUST BE GROUNDED.

- To ensure the safe operation of the inverter, it must be installed and commissioned by qualified personnel in full compliance with the warnings laid down in the MICROMASTER 420 operating instructions.
- Take particular note of the general and regional installation and safety regulations regarding work on dangerous voltage installations (e.g. EN 50178), as well as the relevant regulations regarding the correct use of tools and personal protective gear.
- The mains input, DC and motor terminals carry dangerous voltages even if the inverter is inoperative, wait **5 minutes** to allow the unit to discharge after switching off before carrying out any installation work.

Frame Size A

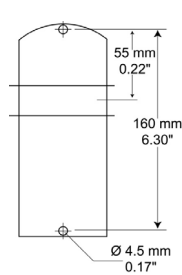

Frame Size B

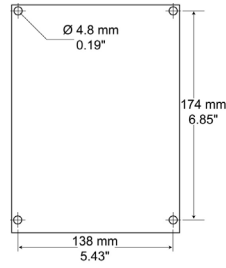

Frame Size C

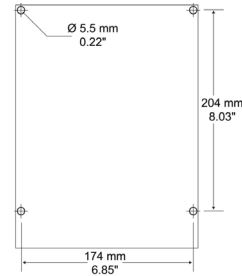

Drill pattern for MICROMASTER 420

Frame-Size	Overall Dimensions			Fixing Method	Tightening Torque
	Height	Width	Depth		
A	173mm	73mm	149mm	2 x M4 Bolts 2 x M4 Nuts 2 x M4 Washers Connecting to DIN rail	2.5Nm with washers fitted
B	202mm	149mm	172mm	4 x M4 Bolts 4 x M4 Nuts 4 x M4 Washers	2.5Nm with washers fitted
C	245mm	185mm	195mm	4 x M5 Bolts 4 x M5 Nuts 4 x M5 Washers	3.0Nm with washers fitted

Frame Size measurements and fixing methods

2 Electrical Installation



Warning

- Before electrical installation, set the power supply frequency for Europe or North America. For operation on the North American Power Supply, set the DIP-Switch (2) to 60 Hz (up). For operation on the European Power Supply, leave the DIP-Switch (2) in the default position 50 Hz (down).
- When installing the inverter after a period of storage please refer to Section 2 of the Operating Instructions
- DIP-Switch 1 is not used.

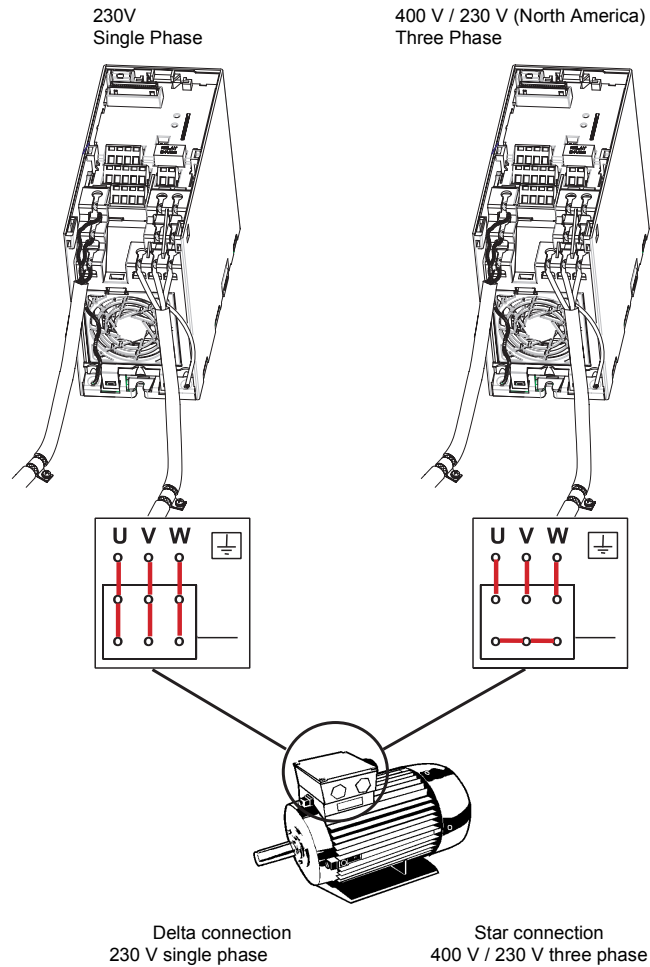

Note

Motors above 11kW are normally configured 400V Delta or 690 V Star. Motor should be connected appropriately according to the output voltage of the inverter. For further information refer to the Operating Instructions of the motor.

3 Avoiding Electro-Magnetic Interference

The inverters are designed to operate in an industrial environment where a high level of EMI can be expected. Usually, good installation practices will ensure safe and trouble-free operation. If you encounter problems, follow the guidelines stated below.

Actions to Take

- Ensure that all equipment in the cubicle is well grounded using short, thick grounding cable connected to a common star point or busbar
- Make sure that any control equipment connected to the inverter (such as a PLC) is connected to the same ground or star point as the inverter via a short, thick link
- Connect the return ground from the motors, directly to the ground connection (PE) on the associated inverter
- Flat conductors are preferred as they have lower impedance at higher frequencies
- Terminate the ends of the cable neatly, ensuring that unscreened wires are as short as possible
- Separate the control cables from the power connections as much as possible, using separate trunking, if necessary at 90° right angles.
- Whenever possible, use screened leads for the connections to the control circuitry
- Ensure that contactors inside the cubicle are suppressed, either with R-C suppressors for AC contactors or 'flywheel' diodes for DC contactors fitted to the coils. Varistor suppressors are also effective. This is important when the contactors are controlled from the inverter relay
- Use screened or armored connections for the motor connections and ground the screen at both ends using cable clamps



Warning

Safety regulations **must not** be compromised when installing inverters!

4 Commissioning the MICROMASTER 420 Inverter

The MM420 is supplied with a Status Display Panel (SDP). Default parameter settings cover the following requirements:

- The motor rating data, Voltage, Current and Frequency are all compatible with the inverter data. (A standard Siemens motor is recommended).
- Linear V/f motor speed, controlled by an analogue potentiometer.
- Maximum speed 3000 min^{-1} with 50 Hz (3600 min^{-1} with 60 Hz), Controllable using a potentiometer via the inverter's analogue inputs
- Ramp-up time / Ramp-down time = 10 s

If more complex application settings are required, please refer to the parameter listing in the Operating Instructions.

For changing parameters you need one of the optional modules "Basic Operator Panel" (BOP), "Advanced Operator Panel" (AOP) or communication options. See Operating Instructions and Reference Manual.

In this Guide, Commissioning with SDP and "Quick Commissioning" with the BOP (including the necessary parameters) are explained.

For replacing the SDP by an Operator Panel see Section 6

Note:

Frequency setting: The inverter is delivered as follows:

- DIP switch 2:
 - ◆ Off position: European defaults (50Hz, kW etc.)
 - ◆ On position: North American defaults (60Hz, hp etc.)
- DIP switch 1: Not for customer use.

4.1 Default Settings

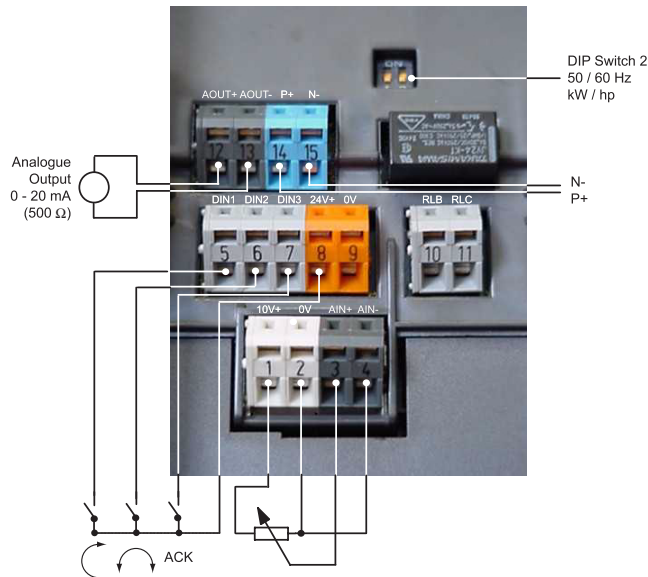

Digital inputs	Terminals	Parameter	Default operation
1	5	P0701 = '1'	ON right
2	6	P0702 = '12'	Reverse
3	7	P0703 = '9'	Fault Acknowledge
Output relay	10/11	P0731 = '52.3'	Fault Indication
Analogue Output	12/13	P0771 = '21'	Output Frequency

4.2 Commissioning with Getting Started Guide

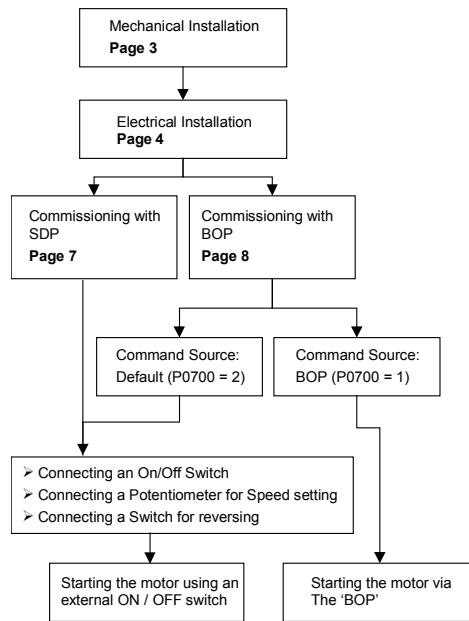

4.3 Commissioning with the Status Display Panel

When commissioning the MICROMASTER 420 with the Status Display Panel (SDP), the drive application must be covered by the default settings of your MICROMASTER 420.

- Connect On/Off Switch to the terminals 5 and 8
- Connect Switch for reversing direction to the terminals 6 and 8 (Optional)
- Connect Switch for fault reset to the terminals 7 and 8 (Optional)
- Connect analog frequency display to the terminals 12 and 13 (Optional)
- Connect Output relay to the terminals 10 and 11 (Optional)
- Connect a **5.0 kΩ** Potentiometer for speed control to the terminals 1 to 4

The Inverter is now ready for starting.

4.4 Commissioning with the Basic Operator Panel

With the Basic Operator Panel, which is available as an option, the user can change the default settings of the MM420 to meet particular application requirements. Using the BOP it is possible to access level one, two and three parameter sets. The BOP hosts the following features:

- Speed, frequency, motor direction and current etc displayed as required
- For direct control, the BOP is mounted directly onto the front panel of the inverter



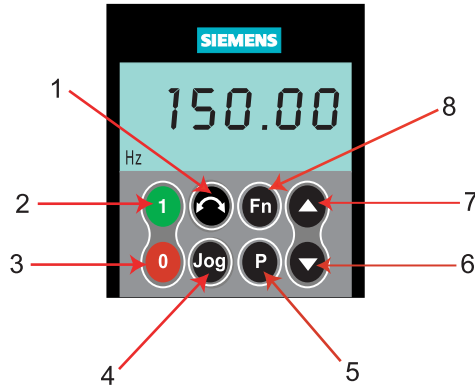











For "Quick Commissioning" of the inverter the Getting Started Guide should be used. For other methods of commissioning, see the Operating Instructions or Reference Manual.



1. Change Direction Changes the direction of rotation of the motor. Reverse is indicated by a minus (-) sign.
2. Start Inverter This button starts the inverter. This button is disabled by default. To enable this button set P0700 to 1.
3. Stop Inverter This button stops the motor in the time set in P1121 (Ramp-down time).
4. Jog Motor While the inverter has no output this button causes the motor to start and run at the preset jog frequency. The inverter stops when the button is released.
5. Access Parameters Pressing this button allows the user to access the parameters in the selected user access level.
6. Decrease Value Pressing this button decreases the displayed value. To change the frequency setpoint via the BOP set P1000 = 1 (when P0700 = 1).
7. Increase Value Pressing this button increases the displayed value. To change the frequency setpoint via the BOP set P1000 = 1 (when P0700 = 1).
8. Functions This button can be used to view additional information. See Section 5.1.2 on page 42 of the MICROMASTER 420 Operating Instructions.

4.5 Changing parameters and settings using a 'BOP' / 'AOP'

The following description shows how to change the parameter P1082. Use this description as a guide for setting any parameters using the 'BOP'.

Step	Result on display
1 Press  to access parameters	P(1) r0000
2 Press  until P0010 is displayed	P(1) P0010
3 Press  to access P0010 Value level	P(1) 0
4 Press  to set P0010 = 1	P(1) 1
5 Press  to save and exit value level	P(1) P0010
6 Press  until P1082 is displayed	P(1) P1082
7 Press  to access P1082 value level	P(1) 50.00
8 Press  to select desired maximum frequency.	P(1) 35.00
9 Press  to save and exit value level	P(1) P1082
10 Press  to return to P0010	P(1) P0010
11 Press  to access P0010 value level	P(1) 1
12 Press  to return value to P0010 = 0	P(1) 0
13 Press  to save and exit value level	P(1) P0010
14 Press  to return to r0000	P(1) r0000
15 Press  to exit Parameterization The LCD will alternate between actual frequency and the requested frequency setpoint	P(1) 35.00 P(1) 00.00

The required maximum frequency has now been stored.

5 Quick Commissioning

The following parameters must be followed through in their entirety to ensure optimised and efficient operation of the inverter. Please note that P0010 must be set to '1 = Quick Commissioning' to allow this procedure to be carried out.

For information on how to change parameter settings, please refer to section 4.5 of this guide.

<p>P0010 Start Quick Commissioning 0 = Ready to Run 1 = Quick Commissioning 30 = Factory Setting Please note that P0010 must always be set back to '0' before operating the motor. However if P3900 = 1 is set after commissioning this is done automatically</p>	<p>P0700 Selection of Command Source § (on / off / reverse) 0 = Factory Setting 1 = Basic Operator Panel 2 = Terminal / Digital Inputs</p>
<p>P0100 Operation for Europe / N. America 0 = Power in kW; <i>f</i> default 50 Hz 1 = Power in hp; <i>f</i> default 60 Hz 2 = Power in kW; <i>f</i> default 60 Hz Note: settings 0 & 1 should be changed using the DIP switches to allow permanent setting.</p>	<p>P1000 Selection of Frequency Setpoint § 0 = No frequency setpoint 1 = BOP frequency control  2 = Analogue Setpoint</p>
<p>P0304 *Rated Motor Voltage 10 – 2000 V Nominal motor voltage (V) from rating plate</p>	<p>P1080 Min. Motor Frequency Sets minimum motor frequency (0-650Hz) at which the motor will run irrespective of the frequency setpoint. The value set here is valid for both clockwise and anti-clockwise rotation</p>
<p>P0305 *Rated Motor Current 0 – 2 x inverter rated current (A) Nominal motor current (A) from rating plate</p>	<p>P1082 Max. Motor Frequency Sets maximum motor frequency (0-650Hz) at which the motor will run at irrespective of the frequency setpoint. The value set here is valid for both clockwise and anti-clockwise rotation</p>
<p>P0307 *Rated Motor Power 0 – 2000 kW Nominal motor power (kW) from rating plate. If P0100 = 1, values will be in hp</p>	<p>P1120 Ramp-Up Time 0 – 650 s Time taken for the motor to accelerate from standstill up to maximum motor frequency.</p>
<p>P0310 *Rated Motor Frequency 12 – 650 Hz Nominal motor frequency (Hz) from rating plate</p>	<p>P1121 Ramp-Down Time 0 – 650 s Time taken for motor to decelerate from maximum motor frequency down to standstill</p>
<p>P0311 *Rated Motor Speed 0 – 40000 1 / min Nominal motor speed (rpm) from rating plate</p>	<p>P3900 End Quick Commissioning 0 = End Quick Commissioning without motor calculation or factory reset. 1 = End Quick Commissioning with motor calculation and factory reset (Recommended) 2 = End Quick Commissioning with motor calculation and with I/O reset 3 = End Quick Commissioning with motor calculation but without I/O reset</p>

5.1 RESET Using P0010 & P0970

When resetting the inverter P0010 must be set to 30 (Factory Setting), it is then possible to set P0970 to '1'. The inverter will automatically reset all its parameters to their default settings. This can prove beneficial if you experience problems during parameter setup and wish to start again.

§ Denotes parameters that contain more detailed lists of possible settings for use in specific applications. Please refer to the Reference Manual and Operating Instructions on the CD

* Motor related parameters—please refer to motor rating plate drawing.

5.2 Motor Data for "Quick Commissioning"

To achieve optimum performance, the MICROMASTER 420 must have the relevant rated motor data set into the correct parameters. The diagram below indicates the data needed from the motor rating plate and the parameters that need to be set to store the information.

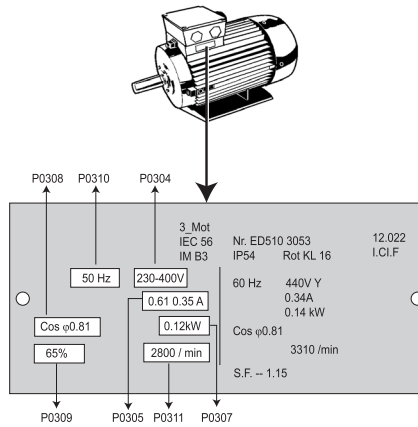

5.3 Starting/Stopping the motor using a 'BOP' (P0700 = 1), (P1000 = 1)

1. Press the green (RUN) button to start the motor.
2. Press the 'UP' button while the motor is turning. Motor speed increases to 50 Hz.
3. When the inverter reaches 50 Hz, press the 'DOWN' button. Motor speed and display are decreased.
4. Change the direction of rotation with the FORWARD / REVERSE button.
5. The red button STOPS the motor.

5.4 Commissioning with the Advanced Operator Panel (AOP)

The **Advanced Operator Panel (AOP)**, which is available as an option, has all the functionality of a Basic Operator Panel and at the same time includes the following features:

- Communication via RS232 interface
- Expanded language facility
- Diagnostic menu and fault finding assistance
- Explanation of active parameters, faults etc
- Speed, frequency, motor direction and current values etc displayed
- Capacity to store and download up to 10 parameter sets

5.5 Additional Control Applications

The MICROMASTER 420 can also be controlled by the following means:

- Digital inputs / Analogue inputs
- Serial Link via USS Protocol
- Automated system via PROFIBUS connection

5.6 Further information ...

For further information about additional control applications, please refer to the Operating Instructions and Reference Manual on the CD delivered with the inverter.



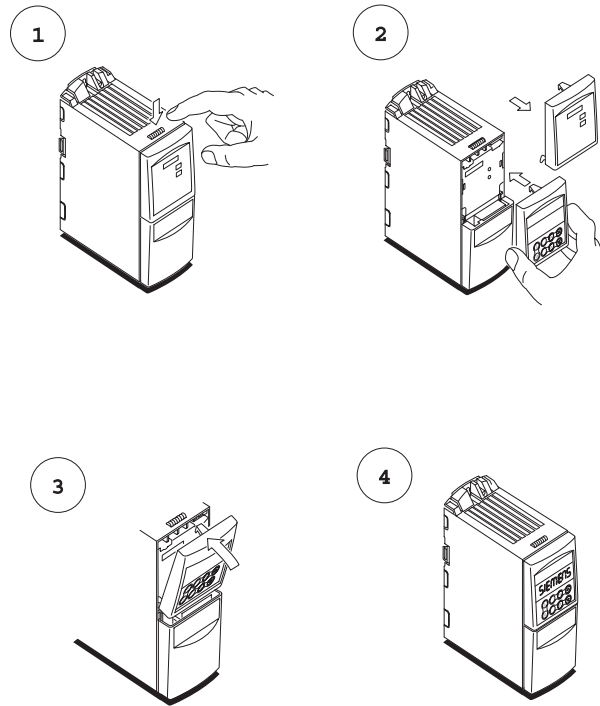

6 Changing the Display / Operator Panel

The procedure for changing the operator panel is illustrated below.



6.1 Changing single digits in Parameter values

For changing the parameter value rapidly, the single digits of the display can be changed by performing the following actions:

1. Ensure you are in the parameter value changing level (see "Changing parameters with BOP").
2. Press  (function button), this causes the right hand digit to blink.
3. Change the value of this digit by pressing  / .
4. Press  (function button) again causes the next digit to blink.
5. Perform steps 2 to 4 until the required value is displayed.
6. Press the  to leave the parameter value changing level and store the value.

7 Troubleshooting

7.1 With the Status Display Panel

The operating status of the inverter is indicated by the green and red LEDs on the Status Display Panel. These LEDs indicate the following warnings and fault states.

Green	Yellow	Priority Display	Drive Status Definitions
OFF	OFF	1	Mains Not present
OFF	ON	8	Inverter Fault - other than ones listed below
ON	OFF	13	Inverter Running
ON	ON	14	Ready to run - standby
OFF	Flashing -R1	4	Fault Overcurrent
Flashing -R1	OFF	5	Fault Overvoltage
Flashing -R1	ON	7	Fault Motor Overtemperature
ON	Flashing -R1	8	Fault Inverter overtemperature
Flashing -R1	Flashing -R1	9	Warning Current limit- Both LEDs Flashing same time
Flashing -R1	Flashing -R1	11	Other Warnings- Both LEDs Flashing Alternately
Flashing -R1	Flashing -R2	6/10	Undervoltage Trip/Undervoltage warning
Flashing -R2	Flashing -R1	12	Drive is not in ready state-Display State>0
Flashing -R2	Flashing -R2	2	ROM Failure- Both LEDs Flashing same time
Flashing -R2	Flashing -R2	3	RAM Failure- Both LEDs Flashing Alternately
R1- On time 900mSec. R2- On time 300mSec.			

7.2 With Operator Panels (BOP & AOP)

The following fault codes for the Basic Operator and Advanced Operator Panels indicate the status of the inverter:

BOP/AOP fault code	Status of MICROMASTER 420 Inverter
F0001	Overcurrent
F0002	Overvoltage
F0004	Inverter overtemperature (internal PTC)
F0011	Motor overtemperature by I ² t calculation

Overcurrent (Fault F0001)

- Ramp up time set too short. Increase P1120 accordingly.
- Voltage boost too high. Reduce parameters P1310, P1311 and P1312 to prevent excessive magnetization of the motor.

Overvoltage (Fault F0002)

- Ramp down time set too short. Increase P1121 accordingly.

Note

It is possible that the motors' performance may be affected at low frequencies if parameter P1310 falls under 50 (default value).

For further fault code designations, please refer to the MICROMASTER 420 Operating Instructions on the CD included with the inverter.

Prerequisites:

Mechanical and electrical Installation are completed.

Setting the supply frequency

DIP Switch 2: Off = 50 Hz / ON = 60 Hz

Power ON



Quick Commissioning P0010 = 1

See Chapter 5. For a lot of applications the inverter will be ready.



Further Commissioning via P0004 and P0003

An overview about the parameter structure is given on the right. A detailed description you will find in the Operating Instructions and in the Reference Manual.

Overall Structure

Example Inverter Unit

(no filter function)
allows direct access to
the parameters depending
on the selected access level

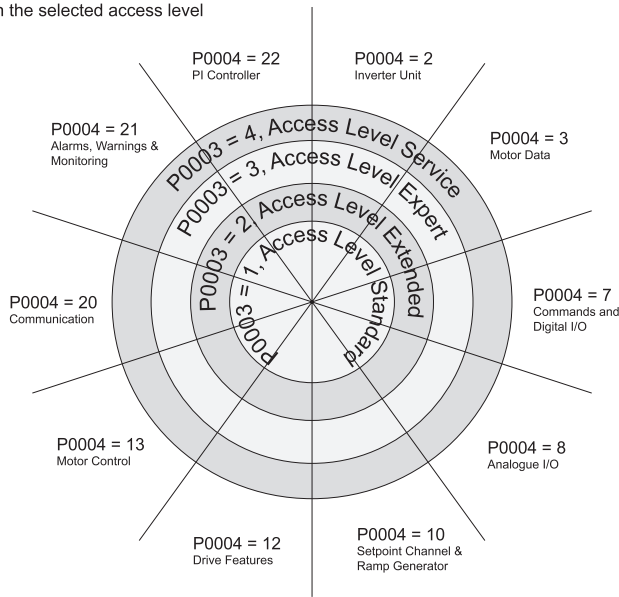

Example Motor Data

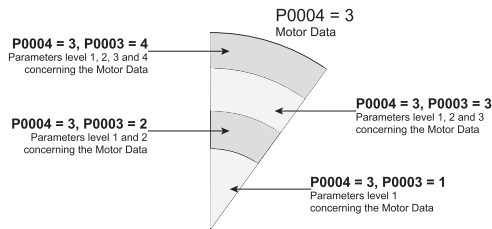



European Low Voltage Directive

The MICROMASTER product range complies with the requirements of the Low Voltage Directive 73/23/EEC as amended by Directive 98/68/EEC. The units are certified for compliance with the following standards:

- EN 60146-1-1 Semiconductor inverters - General requirements and line commutated inverters
- EN 60204-1 Safety of machinery - Electrical equipment of machine

European Machinery Directive

The MICROMASTER inverter series does not fall under the scope of the Machinery Directive. However, the products have been fully evaluated for compliance with the essential Health & Safety Requirements of the directive when used in a typical machine application. A Declaration of incorporation is available on request.

European EMC Directive

When installed according to the recommendations described in this guide, the MICROMASTER fulfils all requirements of the EMC Directive as defined by the EMC Product Standard for Power Drive Systems EN50082-2.



Underwriters Laboratories

UL and CUL LISTED POWER CONVERSION EQUIPMENT 5B33 for use in a pollution degree 2

ISO 9001

Siemens plc operates a quality management system, which complies with the requirements of ISO 9001.

To submit any suggestions for improvements, please visit the Siemens Standard Drives Web Site at <http://www.siemens.de/micromaster>



Order Number: 6SE6400-5AB00-0BP0
Printed in England
Drawing Nr. G85139-K1790-U225-A1

Siemens plc
Automation & Drives
Standard Drives Division
Varey Road,
Congleton, CW12 1PH
United Kingdom